

Introduction

FrSky Tandem X20 series HD radio system provides the perfect solution for FPV flying and pilots preferring an easier operation with fewer devices. The HD version of the X20 radio system includes an integrated FPV screen supporting 720p 60FPS video quality, removing the need for a standalone FPV screen. When combining the HD 720p 60FPS video with near 0ms low latency digital video transmission technology, the X20 HD radio will provide more enjoyment and confidence when FPV flying tours. The built-in video receiver module is compatible with all HDZero video transceiver (VTX) products.

The X20 HD radio package includes a 5.8G antenna kit. The circularly polarized directional antennas ensure that the radio receives optimum video transmission signals, even in complex RF environments. The HD version of the X20 radio also provides an HDMI output which can be used to easily transfer the HD video to an external monitor or device if required, this provides a great solution if you wish to use your existing FPV goggles which support HDMI-in, removing the need for separate HDZero video receiver attached to your goggles.

Overview

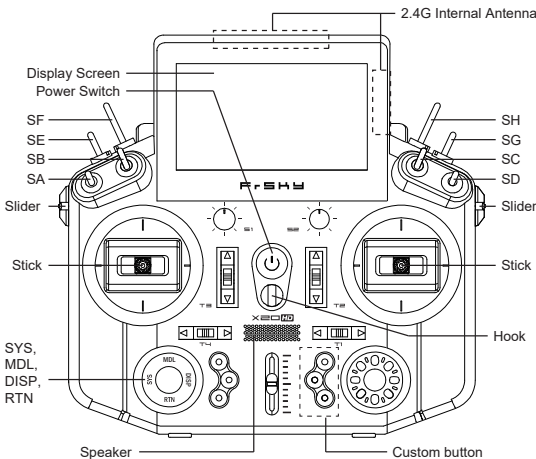

Switch

- SA: 3 positions; Short Lever
- SB: 3 positions; Long Lever
- SC: 3 positions; Long Lever
- SD: 3 positions; Short Lever
- SE: 3 positions; Short Lever
- SF: 2 positions; Long Lever
- SG: 3 positions; Short Lever
- SH: 2 positions; Momentary, Long lever

You can choose the Switch and define its position in the HARDWARE menu.

1. USB port is for upgrading, reading/writing Micro SD cards and internal memory of radio contents and charging. (Micro SD card is not provided with shipment.)
2. Smart Port is for firmware upgrade for all FrSky S.Port devices.

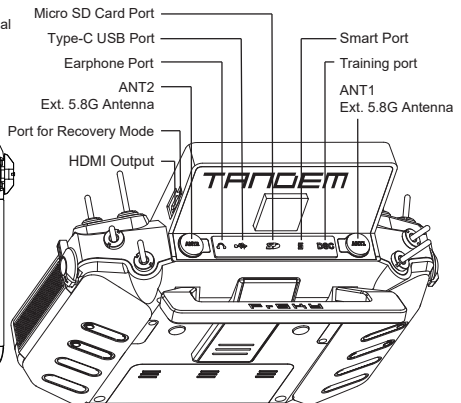
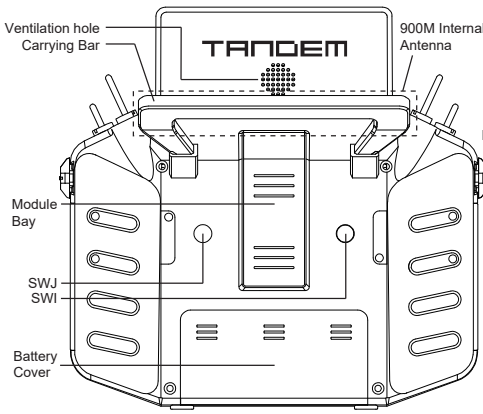

Specifications

- Dimension: 213*200*95 mm (L*W*H)
- Weight: 833g (without battery)
- Operating system: ETHOS
- Internal RF module: TANDEM
- Number of Channels: 24 channels
- Operating Voltage Range: 6.5 ~ 8.4V (2S Li-battery)
- Operating Temperature: -10°C~60°C (14°F~140°F)
- USB Adaptor Voltage: 5V+0.2V
- USB Adaptor Current: >2.0A
- Backlit touchable LCD resolution: 800*480
- Resolution & Frame Rate of HD VTX: 720P 60FPS
- Compatibility: ACCST D16 & ACCESS & TD series receivers

Features

- Built-in near 0ms latency HD digital video transmission system (720P 60FPS)
 - Supports working with HDZero VTX Race V2 , etc.
(Note: the range is dependent on the VTX power setting in use.)
 - Supports HDMI Output
 - 5.8G circularly polarized directional external antennas
- Built-in TD 900M/2.4G Dual-Band Internal RF Module
Supports Multiple Working Modes
 - 2.4G ACCST D16 Mode (Compatible with ACCST Receivers with D16 V2 or later FW)
 - 2.4G ACCESS Mode (Compatible with ACCESS Receivers)
 - 900M ACCESS Mode (Compatible with ACCESS R9 868/915MHz Receivers)
(Capable of simultaneous working under ACCESS mode)
 - 2.4G&900M TD Mode (Compatible with TD Receivers)
- Super-low latency and long-range control with telemetry
 - Up to 50 to 100KM range and down to 4ms end-to-end latency
- 800*480 Color Touch-Screen Displays
- 6 Quick-Mode Custom Buttons (Front) and 2 Momentary Buttons (Rear)
- Lite Type External Module Bay
- Built-in 6-axis Gyroscope Sensor
- All CNC Metal Trim Knobs
- Haptic Vibration Alerts and Voice Speech Outputs
- Supports Recharge System for 2S Li-ion Battery (USB Type-C Interface)
- High-speed PARA Wireless Training System (Compatible with FreeLink App3.0)
- High-Precision Hall-Sensor Gimbals with All-CNC Metal Panel
- ETHOS: The more powerful, Flexible and Intuitive OS for your radio.
 - Clear and Intuitive UI Design
 - Supports Dual Operation Modes of Radio Display (Touch and Non-Touch)
 - Supports Multi-Language Switching
 - Hardware/Software Version and Factory Version Detection
 - Supports running LUA Scripts

2S Li-battery balance charging via USB-C

The Green LED indicator states:

Led on: in charging / **Led off:** end of charge / **Flash:** charge fault

Battery compartment size: 84*41.5*20mm (L*W*H)

- Note:**
1. Charge the battery with the USB adapter (Voltage: 5V+0.2V Current: >2.0A) when you use the USB charging function.
 2. The lower the initial charging voltage, the better the charging effect is when the voltage difference cells exceed 50 mV between the two.

Gimbal adjustment (UpKit version)

Unscrew the four screws on the back cover of the remote control, open the back cover of the remote control, you can adjust Gimbal.

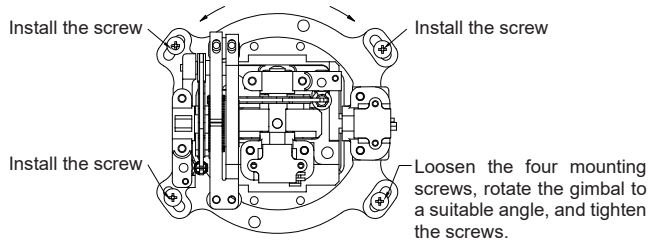

Audio bluetooth (UpKit version)

This Audio module can have your wireless Bluetooth audio devices connected and functioned as a broadcast. Open the wireless settings in the ETHOS system menu, select "Audio" and click "Search", then open your wireless Bluetooth audio device and bound.

Frequency Switch & Video Transmission Configuration on X20HD series radios

- Press the [DISP] button on the Homepage to enter the video transmission system.
- Pressing the center button of the right-side scroll wheel can switch the modes between WakeUp (Enable) and Sleep (Disable) mode for the VRX, and when switching to the Sleep (Disable), the video transmission system is unable to be configured.
- Pressing the [SLS] button can change the frequencies from R1 5658 to R8 5917.
- Using the [MDL] button to switch the Frame Rate between 50FPS and 60FPS.
- Pressing the [RTN] button can exit back to the Homepage.
- Emergency / Short-circuit Port: Insert the Short-cap accessory to retry the firmware upgrade when the firmware upgrade fails for the built-in VRX module. (Please remember to take out the accessory when the upgrade process is completed.)

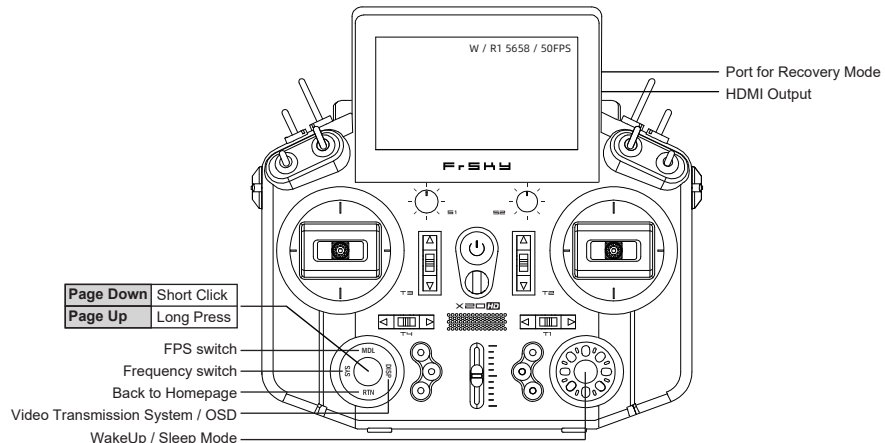

5.8G Antenna (video transmission)

Peak Gain: 8.0dBi@5.5GHz , 7.0dBi@5.785GHz

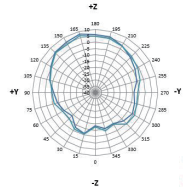
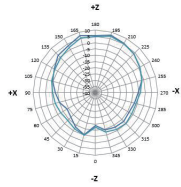
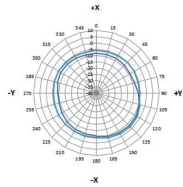
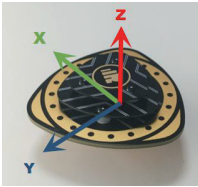

— 5.5GHz
— 5.785GHz

ETHOS Suite

With ETHOS Suite, you can update the radio bootloader, firmware, SD card, flash, and also convert image format and audio format. Find the latest information and download the ETHOS Suite at ethos.frsky-rc.com/.

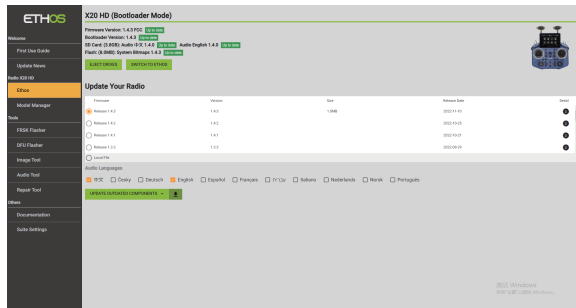

Note: To use the ETHOS Suite application with a FrSky radio, please always keep the radio bootloader with the latest version.

How to upgrade firmware for the video receiver module

- ① Make sure the HD radio is connected to the [ETHOS Suite] program.
- ② Enter the [FRSK Flasher] tool and move to the [HD Video Component] tab;
- ③ Click the [Flash] button of the corresponding radio model to upgrade the firmware.

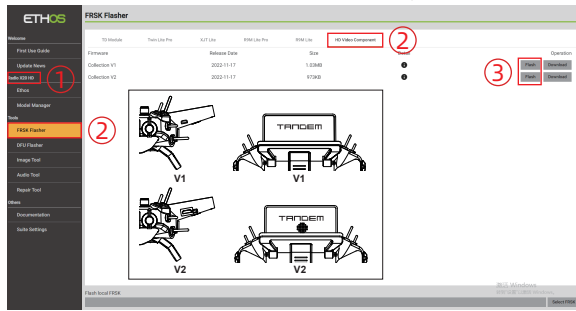

ETHOS Operating System

Create the model

STEP 1:



Enter into Model Select, then select the model type.

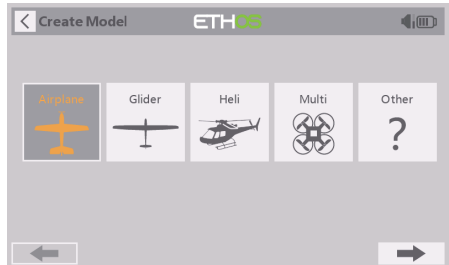

Create a new model.

STEP 2:

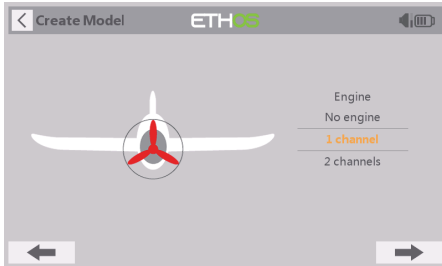

Configure the model channel.



Name the model and set the model picture.

Model Setup Procedure - Internal Module

STEP1: Enable RF Module

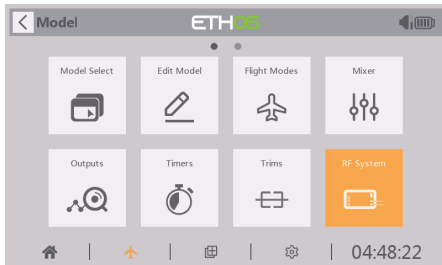

Enter the RF system menu by the touch-screen or use the navigation encoder key.



Choose the Internal Module.

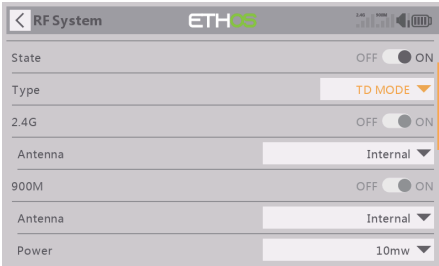

Then turn the state of Internal RF to On. Set the binding mode for the Internal RF module corresponding to the receiver (ACCST D16, ACCESS, TD MODE).

STEP2: Channel Range Setting



TD-ISRM Internal RF module supports 24 channels (CH1-8 / CH1-16 / CH1-24).

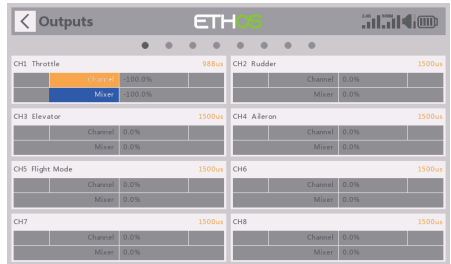

The channel range is configurable by pressing the channel bars, please also make sure of the channel configuration before using the module.

STEP3: Model ID Setting



The system assigns the receiver a number for the receiver (Model ID) automatically while creating a new model. (The Model ID can be set from 00 to 63, with the default ID being 1.)

STEP4: Registration

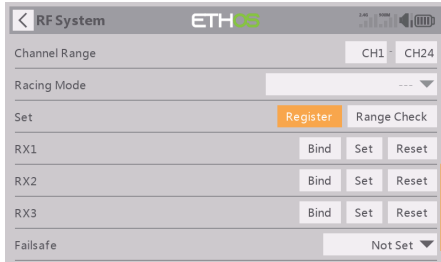

For TD Mode as an example, select the Set [Register] for getting the radio into Registration status in the RF System-Internal Module tool, then press the F/S button on the receiver and power the receiver on.

STEP5: Automatic Binding (Smart Match)

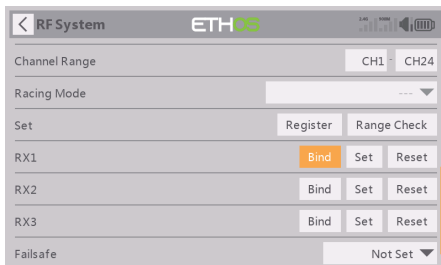

Move the cursor to RX1 [BIND], press it and repower the receiver.



When the "RX Connected" page pops up, press the [REGISTER] to complete the Registration procedure and then power the receiver off. (The system automatically assigns the receiver a UID differently in the same model when you have several receivers to bind at the same time.)

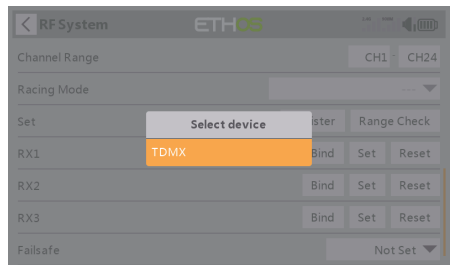

Click the RX to complete the binding after the receiver window pops up, the system will confirm "Bind succeed".

Reset: Registration procedure is not required to repeat anymore after the receiver was once registered even though the receiver is deleted. Pressing the [Reset] and repower the receiver can have the bound recovered.

STEP6: RF Power Setting



The TD-ISRM internal RF Module can offer multiple RF power options which can achieve a further controlling range.

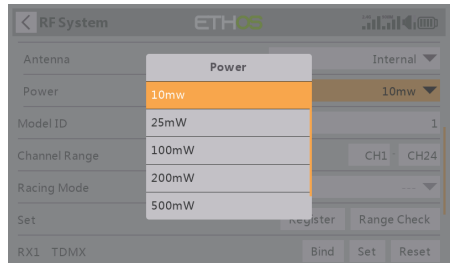

Open the Power menu bar and select the desired power level according to usage.

Range Check

A pre-flight range check should be done before every flight, in case the signal loss is caused by the reflection of the signal by the nearby metal fence or concrete, and the shading of the signal by buildings or trees during the actual flight. Under normal circumstances, in Range Check mode, the RSSI at 150m is about 45-50.

1. Place the model at least 60 cm (2 feet) above the non-metal contaminated ground (such as on a wooden bench). The receiving antenna should be in a vertical position.
2. Enter the ETHOS system, move to the "RF System", scroll the Encoder to select "RANGE" mode and press Encoder. In range check mode, the effective distance will be decreased to 1/30.

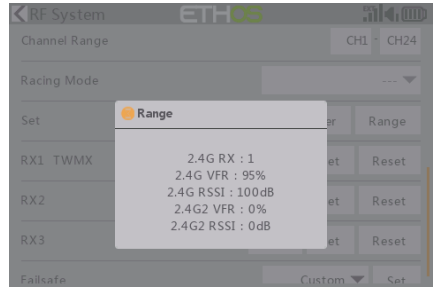
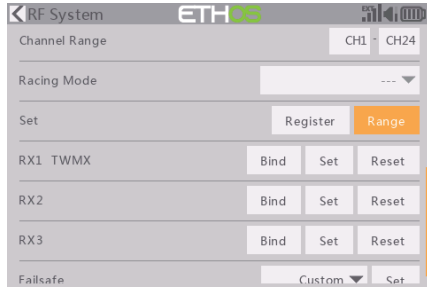

How to set Failsafe

There are 3 failsafe modes when the setting is enabled: No Pulse, Hold, and Custom mode.

- **No Pulses Mode:** On loss of signal, the receiver produces no pulses on any channel. To use this mode, select it in the menu and wait 9 seconds for the failsafe to take effect.
- **Hold Mode:** The receiver continues to output the last positions before the signal was lost. To use this mode, select it in the menu and wait 9 seconds for the failsafe to take effect.
- **Custom Mode:** Pre-set to required positions on the lost signal. Move the cursor to the failsafe mode of the channel and press Encoder, then choose the Custom mode. Move the cursor to the channel you want to set failsafe On and press Encoder. Then rotate the Encoder to set your failsafe for each channel and short-press the Encoder to finish the setting. Wait 9 seconds for the failsafe to take effect.

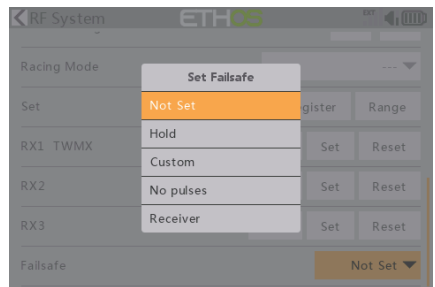
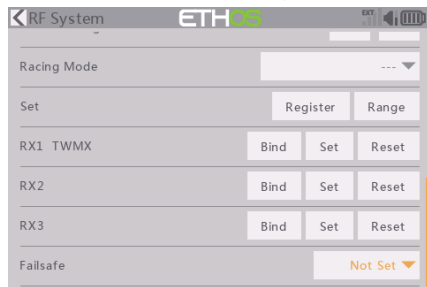

Note:

- If the failsafe is not set, the model will always work with the last working status before the signal is lost. That could cause potential damage.
- When the failsafe is disabled on the RF module side, the failsafe set on the receiver side will be applied.
- SBUS port does not support the failsafe setting in No Pulses mode and always outputs signal. Please set "Hold" or "Custom" mode for the SBUS port.

FCC

This equipment has been tested and found to comply with the limits for a Class B digital device, pursuant to part 15 of the FCC Rules

CE

The product may be used freely in these countries: Germany, UK, Italy, Spain, Belgium, Netherlands, Portugal, Greece, Ireland, Denmark, Luxembourg, Austria, Finland, Sweden, Norway, Switzerland, France and Iceland.

FLYING SAFETY**⚠ Warning:**

To ensure the safety of yourself and others, please observe the following precautions.

① **Have regular maintenance performed.** Although your TANDEM X20 HD protects the model memories with non-volatile EEPROM memory (which does not require periodic replacement) and of a battery, it still should have regular check-ups for wear and tear. We recommend sending your system to your FrSky Service Center annually during your non-flying-season for a complete check-up and service.

Battery

① Using a fully charged battery (DC 6.5~8.4V). A low battery will soon die, causing loss of control and a crash. When you begin your flying session, reset your transmitter's built-in timer, and during the session pay attention to the duration of usage. Also, if your model used a separate receiver battery, make sure it is fully charged before each flying session.

① **Stop flying long before your batteries become over discharged. Do not rely on your radio's low battery warning systems, intended only as a precaution, to tell you when to recharge. Always check your transmitter and receiver batteries prior to each flight.**

Where to Fly

We recommend that you fly at a recognized model airplane flying field. You can find model clubs and fields by asking your nearest hobby dealer.

① **Always pay particular attention to the flying field's rules**, as well as the presence and location of spectators, the wind direction, and any obstacles on the field. Be very careful flying in areas near power lines, tall buildings, or communication facilities as there may be radio interference in their vicinity.

At the flying field

- ① To prevent possible damage to your radio gear, turn the power switches on and off in the proper sequence:
1. Pull throttle stick to idle position, or otherwise disarm your motor/engine.
 2. Turn on the transmitter power and allow your transmitter to reach its home screen.
 3. Confirm the proper model memory has been selected.
 4. Turn on your receiver power.
 5. Test all controls. If a servo operates abnormally, don't attempt to fly until you determine the cause of the problem.
 6. Start your engine.
 7. Complete a full range check.
 8. After flying, bring the throttle stick to idle position, engage any kill switches or otherwise disarm your motor/engine.

If you do not turn on your system on and off in this order, you may damage your servos or control surfaces, flood your engine, or in the case of electric-powered or gasoline-powered models, the engine may unexpectedly turn on and cause a severe injury.

- ① **Make sure your transmitter can't tip it over.** If it is knocked over, the throttle stick may be accidentally moved, causing the engine to speed up. Also, damage to your transmitter may occur.
- ① In order to maintain complete control of your aircraft it is important that it remains visible at all times. Flying behind large objects such as buildings, grain bins, etc. must be avoided. Doing so may interrupt the radio frequency link to the model, resulting in loss of control.
- ⊗ Do not grasp the transmitter's antenna during flight. Doing so may degrade the quality of the radio frequency transmission and could result in loss of control.
- ⊗ As with all radio frequency transmissions, the strongest area of signal transmission is from the sides of the transmitter's antenna.
- ① **Don't fly in the rain!** Water or moisture may enter the transmitter through the antenna or stick openings and cause erratic operation or loss of control. If you must fly in wet weather during a contest, be sure to cover your transmitter with a plastic bag or waterproof barrier. Never fly if lightning is expected.

Updates

FrSky is continuously adding features and improvements to our radio systems. Updating (via USB Port or the Micro SD card) is easy and free. To get the most from your new transmitter, please check the download section of the FrSky website for the latest update firmware and guide for adjusting your sticks. (www.frsky-rc.com)

FrSky is continuously adding features and improvements to our products. To get the most from your product, please check the download section of the FrSky website www.frsky-rc.com for the latest update firmware and manuals